



REPUBLIKA HRVATSKA
Ministarstvo gospodarstva
i održivog razvoja



REPUBLIC of CROATIA
Ministry of Economy and
Sustainable Development

KATALOG HRVATSKIH PROIZVOĐAČA

CROATIAN ROBOTICS
COMPANIES CATALOGUE

ROBOTIKA

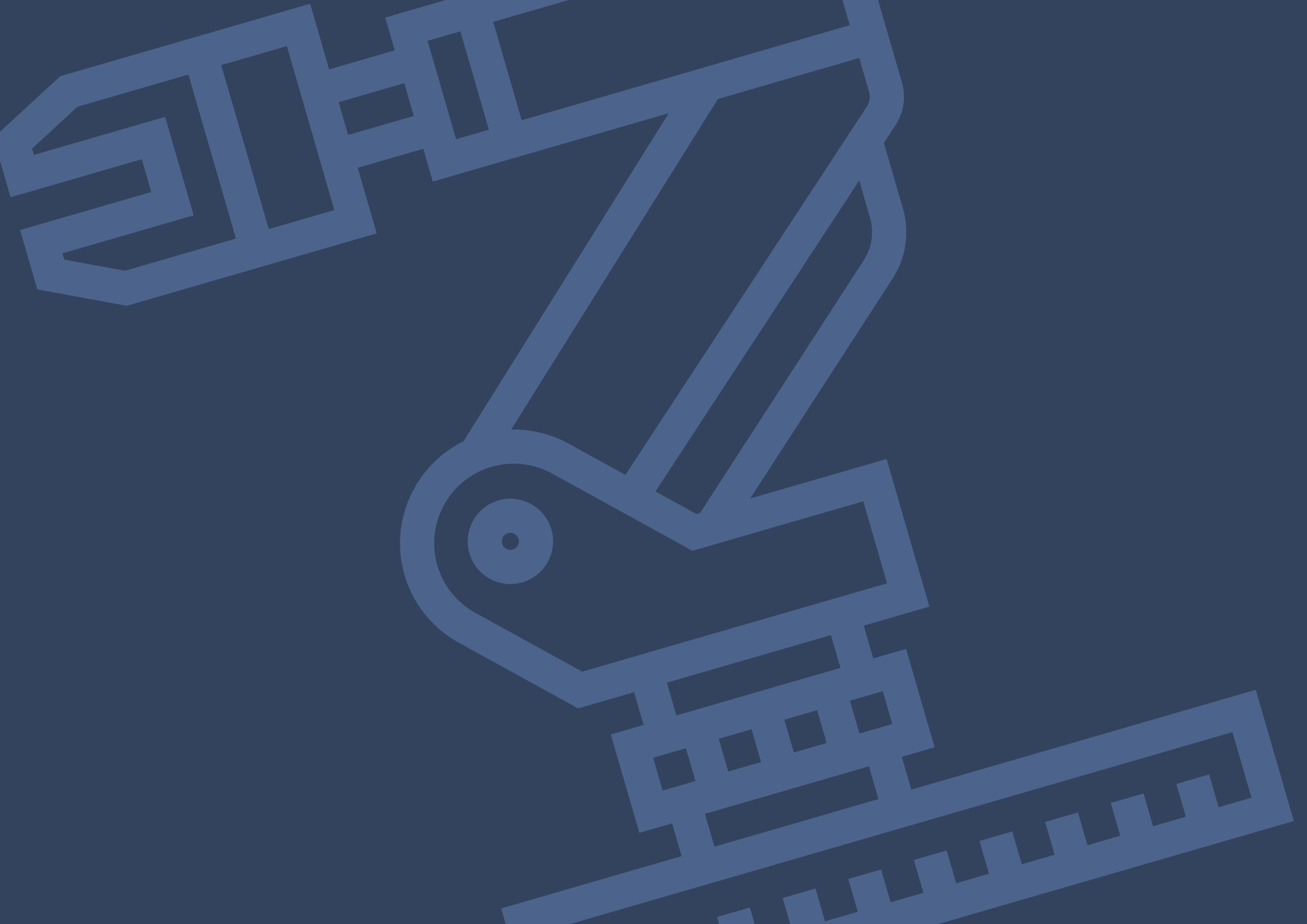

SADRŽAJ

CONTENTS

| | | | |
|--|----|---|----|
| Značaj, veličina i potencijal robotike | 4 | Significance, size, and potential of robotics | 5 |
| Poduzeća iz područja robotike | 6 | Croatian Robotics Companies | 7 |
| AIR RMLD | 10 | AIR RMLD | 10 |
| ATINEL | 11 | ATINEL | 11 |
| Autron | 12 | Autron | 12 |
| Average Solutions | 13 | Average Solutions | 13 |
| Byte Lab | 14 | Byte Lab | 14 |
| Codel | 15 | Codel | 15 |
| DOK-ING | 16 | DOK-ING | 16 |
| Gideon Brothers | 17 | Gideon Brothers | 17 |
| Hennlich | 18 | Hennlich | 18 |
| Inetec | 19 | Inetec | 19 |
| Probotica | 20 | Probotica | 20 |
| Proel | 21 | Proel | 21 |
| Purić | 22 | Puric | 22 |
| Romb Technologies | 23 | Romb Technologies | 23 |
| Ronna | 24 | Ronna | 24 |
| Stemi | 25 | Stemi | 25 |
| Strojotehnika | 26 | Strojotehnika | 26 |
| V&R Automated Systems | 27 | V&R Automated Systems | 27 |
| Kontakti | 28 | Contacts | 28 |

ZNAČAJ, VELIČINA I POTENCIJAL ROBOTIKE

Robotika je multidisciplinarno područje koje uključuje specijalizacije elektrotehnike, strojarstva i računarstva, a danas igra ključnu ulogu u suvremenim ekonomijama diljem svijeta. Roboti se razvijaju, proizvode i primjenjuju u raznovrsnim sektorima industrije, zdravstva, logistike, poljoprivrede, istraživanja svemira i drugih područja.

U svjetskim ekonomijama rastuća uporaba robota pokazuje značajan utjecaj na povećanje produktivnosti, smanjenje troškova proizvodnje te poboljšanje kvalitete proizvoda i usluga.

Hrvatska poduzeća koja se bave robotikom pokrivaju širok spektar razvoja, proizvodnje i primjene robotskih tehnologija: od autonomnih mobilnih robota koje razvijaju Gideon Brothers i Romb Technologies, integratora

kompleksnih robotskih sustava kao što su ATINEL, Codel i Strojotehnika, do razvoja specijalnih robota za nuklearnu industriju (Inetec) i medicinsku primjenu (RONNA Medical).

Kroz ovaj katalog, prikazano je područje rada 18 poduzeća iz područja robotike koja svojim inovativnim pristupom, tehnološkim dostignućima i visokim standardima kvalitete pružaju širok spektar rješenja u robotici diljem svijeta. Ta poduzeća nositelji su inovacija u području robotike u Republici Hrvatskoj, čija rješenja ne samo da prate najnovije tehnološke trendove, već postavljaju i nove standarde u razvoju robotskih rješenja u globalnim okvirima.

SIGNIFICANCE, SIZE AND POTENTIAL OF ROBOTICS

The multidisciplinary field of robotics, drawing on electrical engineering, mechanical engineering, and computer science, plays a vital role in modern economies globally. Robots are developed, produced, and applied across numerous sectors, from industry and healthcare to logistics, agriculture, and even space exploration.

The growing adoption of robots demonstrably increases productivity, reduces production costs, and enhances the quality of products and services, making them a vital player in modern economies worldwide, including Croatia.

Croatian companies are actively involved in the entire spectrum of robotics development, production, and ap-

plication, including pioneering autonomous mobile robots (Gideon Brothers, Romb Technologies), leading complex robotic systems integration (ATINEL, Codel, Strojotehnika), and developing specialized robots for the nuclear industry (Inetec) and medical applications (RONNA Medical).

This publication showcases 18 such companies that deliver a vast array of innovative robotic solutions around the globe. Their achievements in technology and commitment to high standards make them the standard-bearers for robotics innovation in Croatia. These companies not only keep pace with the latest trends but also push boundaries in the global robotics landscape.

PODUZEĆA U REPUBLICI HRVATSKOJ IZ PODRUČJA ROBOTIKE

U Republici Hrvatskoj postoji niz poduzeća koja se bave razvojem, proizvodnjom i primjenom robotskih tehnologija i automatiziranih sustava, ali isto tako certificiranjem, nadzorom i edukacijom u tom području. S obzirom na to da prema Nacionalnoj klasifikaciji djelatnosti (NKD) ne postoji područje koje se odnosi isključivo na projektiranje, istraživanje i razvoj sustava za robotiku i automatizaciju, teško je precizno utvrditi ukupnan broj poduzeća koja se bave robotikom u Hrvatskoj, jer su ta poduzeća raspoređena u različitim NKD kategorijama. Međutim, u području NKD kategorija povezanih s aktivnostima robotike, poput 28.22 – Proizvodnja proizvoda za dizanje i prenošenje i 28.99 – Proizvodnja ostalih strojeva za posebne namjene u Republici Hrvatskoj aktivna su 152 poduzetnika koji zapošljavaju nešto više od 2138 ljudi te ostvaruju više od 250 milijuna eura prihoda, od čega 45 % od izvoza i gotovo 30 milijuna eura dobiti.*

U nastavku je detaljniji opis onih poslovnih subjekata koji su iskazali interes za predstavljanje u Katalogu, a detektirani su temeljem vlastitog istraživanja i podataka dobivenih od Regionalnog centra izvrsnosti za robotske tehnologije (CRTA) pri Fakultetu strojarstva i brodogradnje Sveučilišta u Zagrebu. Većina predstavljenih poduzeća bavi se područjem istraživanja, razvoja i proizvodnje robota i robotiziranih sustava, odnosno softvera za automatizaciju poslovnih procesa, dok je nekoliko poduzeća iz područja edukacije, certificiranja, testiranja i nadzora. Uz kratak opis djelatnosti poduzeća, pronaći ćete popis ključnih proizvoda, odnosno usluga, postojećih certifikata, referenci te kontakt osobe odgovorne za prodaju, odnosno uspostavu suradnje s potencijalnim partnerima u zemlji i inozemstvu.

* Fina (InfoBiz), 2024 za 2022

CROATIAN ROBOTICS COMPANIES

Croatia boasts a dynamic robotics sector, with companies involved in various aspects of the field. These activities include development, production, and application of robotic technologies and automated systems, as well as certification, supervision, and education.

Unfortunately, the Statistical Classification of Economic Activities (NACE) doesn't have a dedicated category for robotics and automation design, research, and development. This makes it difficult to pinpoint the exact number of robotics companies in Croatia, as these companies are spread across various NACE categories.

While precise numbers are elusive, looking at NACE categories related to robotics activities, such as NACE 2822 (Manufacture of lifting and handling equipment) and NACE 2899 (Manufacture of other special-purpose machinery), reveals 152 active companies in Croatia. These companies employ over 2,138 people and generate more than €250 million in revenue, with 45% coming from exports and nearly €30 million in profit.*

* Fina (InfoBiz), 2024 for 2022

This Catalogue provides a short overview of some Croatian robotics companies. These companies were identified through a combination of internal research and data obtained from the Regional Centre of Excellence for Robotic Technology (CRTA) at the University of Zagreb's Faculty of Mechanical Engineering and Naval Architecture.

The majority of companies in this Catalogue focus on research, development, and production of robots, robotic systems, and automation software. A smaller number specialize in robotics education, certification, testing, and supervision.

Each company entry offers a brief description of their activities, along with key products and services, existing certifications, references, and contact information for sales and potential partnerships.

| NAZIV PODUZEĆA COMPANY | PODRUČJE RADA FIELD OF ACTIVITY | ADRESA ADDRESS | KONTAKT CONTACT |
|--|---|--|--------------------------------|
| AIR RMLD d.o.o. | Automatizirane letjelice/dronovi Automated aircraft/drones | Jarunska ulica 19, 10000 Zagreb | air-rmld.com |
| ATINEL d.o.o. | Automatizacija u industriji i građevini Automation in industry and construction | Kučanska ulica 2, 42000 Varaždin | atinel.hr |
| Autron d.o.o. | Automatizacija u industriji Automation in industry | Ulica bana Josipa Jelačića 22/B, 40000 Čakovec | autron.hr |
| Average Solutions d.o.o. | Automatizacija tvornica u automobilske industriji Factory automation in the automotive industry | Petrinska ulica 73, 10000 Zagreb | average-solutions.hr |
| Byte Lab Grupa d.o.o. | IoT sustavi i industrijska elektronička rješenja IoT systems and industrial electronic solutions | Medarska ulica 69/1, 10000 Zagreb | byte-lab.com |
| Codel d.o.o. | Robotski sustavi - automatizacija u industriji Robotic systems – automation in industry | Ulica Franje Tuđmana 20, 48260 Križevci | codel.hr stock-master.co.uk |
| DOK-ING d.o.o. | Robotski i autonomni sustavi za posebne namjene Heavy duty robotic and autonomus systems for special purposes | Slavonska avenija 22/G, 10000 Zagreb | dok-ing.com |
| Gideon Brothers d.o.o. | Autonomni mobilni roboti Autonomous mobile robots | Šamačka 7, 31000 Osijek | gideon.ai |
| Hennlich d.o.o. | Robotika i automatizacija u industriji Robotics and automation in industry | Stupničkoobreška ulica 17, 10255 Stupnički Obrež | hennlich.hr |
| Inetec – Institut za nuklearnu tehnologiju d.o.o. | Specijalizirani robotski sustavi za inspekcije na nuklearnim elektranama Specialized robotics system for nuclear power plants inspection | Dolenica 28, 10255 Donji Stupnik | inetec.hr |

| NAZIV PODUZEĆA COMPANY | PODRUČJE RADA FIELD OF ACTIVITY | ADRESA ADDRESS | KONTAKT CONTACT |
|---|--|--|---------------------------|
| Probotica d.o.o. | Automatizacija u mehatronici i procesnoj industriji Automation in mechatronics and process industry | Slavonska avenija 6/A, 10000 Zagreb | probotica.hr |
| Proel Automatizacija d.o.o. | Automatizacija u industriji Automation in industry | Radnička cesta 177, 10000 Zagreb | proel-automatizacija.com |
| Purić d.o.o. | Automatizacija u industriji Automation in industry | Ulica Andrije Hebranga 54, 10430 Samobor | puric.hr damko.hr |
| Romb Technologies d.o.o. | Softverska rješenja za autonomnu navigaciju u intralogistici Software solutions for autonomous navigation in intralogistics | Martićeve ulica 55, 10000 Zagreb | romb-technologies.hr |
| Ronna Medical d.o.o. | Robotski sustavi za primjenu u neurokirurgiji i proizvodnji dopunskih medicinskih uređaja Robotic systems for use in neurosurgery and the production of supplementary medical devices | Slavonska avenija 6, 10000 Zagreb | ronna-medical.hr |
| Stemi d.o.o. | STEM edukacija STEM edukacija | Ulica Radmile Matejčić 10, 51000 Rijeka | stemi.education |
| Strojotehnika d.o.o. | Robotski sustavi – automatizacija u industriji Robotic systems – automation in industry | Zagorska ulica 10, 10360 Soblinec | strojotehnika.hr |
| V&R Automated Systems d.o.o. | Automatizacija u industriji Automation in industry | Ulica Ivana Keleka 18/A, 10360 Sesvete | var.hr |

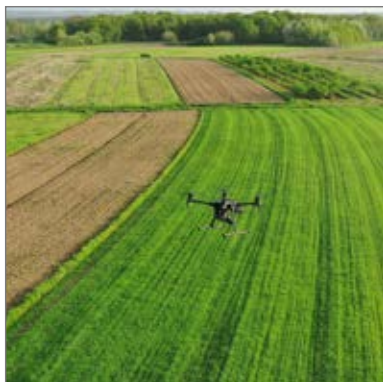

AIR-RMLD

AIR-RMLD

PODUZEĆE ZA RJEŠENJA ZA DRONOVE

- **Proizvodnja i razvoj bespilotnih letjelica**
- **Razvoj, podrška i konzultantske usluge za razvoj usluga upotrebe dronova i bespilotnih letjelica**
- **Pregled plinovoda dronovima**
- **Pregled dalekovoda dronovima**
- **Pošumljavanje pomoću dronova**
- **Dostava i prijevoz tereta pomoću dronova**

DRONE SOLUTION COMPANY

- Production and development of unmanned aerial vehicles
- Development, support, and consultancy for the development of services for the use of drones and unmanned aerial vehicles
- Inspection of gas pipelines by drones
- Inspection of power lines by drones
- Afforestation using drones
- Delivery and transportation of cargo using drones



Jarunska 19, Zagreb
www.air-rmld.com

Milan Domazet
milan.domazet@air-rmld.com
+ 385 91 591 1632

KLJUČNI PROIZVODI

- AIR-RMLD dron za pregled plinovoda uz kontrolu propuštanja
- PROJEKT 02 – pošumljavanje pomoću dronova UAV
- Mosquito AI analysis - kontroliranje najezda komaraca upotrebom dronova

KEY PRODUCTS

- AIR-RMLD pipeline inspection drone with leak control
- PROJECT 02 – afforestation using drones UAV
- Mosquito AI analysis – controlling mosquito infestations using drones

REFERENCE REFERENCES PLINACRO, HOPS, HRVATSKA POŠTA/CROATIAN POST, HRVATSKI TELEKOM /CROATIAN TELECOM, MAGIC FOREST

STANDARDI I CERTIFIKATI STANDARDS AND CERTIFICATES AIR-RMLD, PROJEKT 02, Zaštićeni žigovi / Protected trademarks

IZVOZNA TRŽIŠTA Njemačka, Slovenija, Mađarska, Srbija, BIH, Crna Gora, Kosovo
EXPORT MARKETS Germany, Slovenia, Hungary, Serbia, Bosnia and Herzegovina, Montenegro, Kosovo

Poduzeće za inženjerstvo u automatici, telekomunikacijama, informatici i elektrici. Radi za neka od najvećih i najvažnijih imena u auto industriji u području automatizacijskih usluga i savjetovanja.

Specialized company that strives to deliver unparalleled automation services for large-scale companies throughout the world. They have been working for the largest, most notable car industry companies delivering top-notch automation services and counseling.



Kučanska ulica 2, Varaždin
www.atinel.hr

Krešimir Androlić
androlic@atinel.hr
+385 91 4921 202

PROIZVODI

- programiranje i puštanje u pogon PLC-ova i industrijskih robota
- virtualno puštanje u pogon
- ADAPTO sustavi za različite aplikacije s kolaborativnim robotima
- izrada rješenja „ključ u ruke“
- elektroprojektiranje
- izrada elektro-upravljačkih ormara

KEY PRODUCTS

- programming and commissioning of PLCs and industrial robots
- virtual commissioning service
- ADAPTO systems for various applications with collaborative robots
- creation of turnkey solutions
- electrical design
- production of electrical switchboards

REFERENCE REFERENCES

Daimler Mercedes-Benz (Hambach, Kecskemet, Bremen), BMW (Dingolfing, Regensburg, Spartanburg), MAGNA Graz (BMW, Jaguar, Toyota, Mercedes G), AUDI (Ingolstadt, Neckarsulm), VW (Zwickau, Bratislava, Hannover), Continental Austrian Airlines...

STANDARDI I CERTIFIKATI STANDARDS AND CERTIFICATES

ISO 9001, ISO 14001
IZVOZNA TRŽIŠTA Mađarska, Njemačka, Austrija, Slovenija, Slovačka, Srbija
EXPORT MARKETS Hungary, Germany, Austria, Slovenia, Slovakia, Serbia



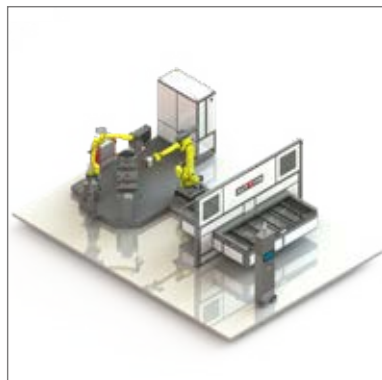
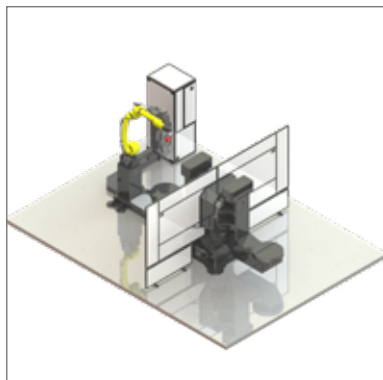

AUTRON



Poduzeće za automatizaciju i robotiku čija stručnost leži u projektiranju i izradi robotskih sustava za industrijsku automatizaciju, pružajući pritom visokokvalitetna rješenja prilagođena jedinstvenim potrebama kupaca te obuhvaćajući cjelokupni proces od konceptualnog razvoja ideje do implementacije krajnjeg sustava.

An automation and robotics company who specializes in the design and manufacture of robotic systems for industrial automation, providing high-quality solutions tailored to the unique customer needs and covering the entire process from the conceptual development to the implementation of the final system.



Ulica bana Josipa Jelačića 22B,
Čakovec
www.autron.hr

Nikola Kirić
nikola@autron.hr
+385 98 965 5417

PROIZVODI

- proizvodnja robotskih stanica
- nadogradnja robotskih stanica
- izrada naprava i gripera
- programiranje robota (OLRP)
- optimizacija robotskih procesa
- proizvodnja strojeva posebne namjene

KEY PRODUCTS

- production of robotic cells
- upgrading robotic cells
- designing jigs and grippers
- robot programming (OLRP)
- optimization of robotic processes
- manufacturing of custom-purpose machines

KAPACITET PROIZVODNJE 2-10 robotskih stanica - ovisno o kompleksnosti stanice

ANNUAL PRODUCTION CAPACITY 2-10 robotic cells – depending on the cell complexity

REFERENCE REFERENCES Centrometal, Maring

AVERAGE SOLUTIONS

<>ERAGE SOLUTIONS

i4.1 [r]evolution

Poduzeće od devet zaposlenih kojem je primarna djelatnost automatizacija proizvodnih linija. Bave se projektiranjem elektrike i automatike proizvodnih linija. Za proizvodne linije izrađuju softver za upravljanje i simulaciju i puštanje u pogon.

Specialized company with nine employees, whose primary job is the automation of production lines. They are engaged in electrical and automation design. For production lines they develop control software and simulation. They also work on commissioning of production lines.



Petrinjska ulica 73, Zagreb
average-solutions.hr

Marko Bunić
marko.bunic@avs.hr
+385 95 386 6969

PROIZVODI

- Softver za upravljanje proizvodnim linijama (PLC i Robot)

KEY PRODUCTS

- Software for production line control (PLC and Robots)

REFERENCE Linija za sastavljanje baterijskih paketa, BMW, Leipzig (Njemačka); Linija za antikorozijsku zaštitu, BMW Leipzig (Njemačka); Linija za umetanje zaštitnih čepova na karoseriju vozila, BMW Munchen (Njemačka); Linija za demontažu nosača karoserije, BMW, Dingolfing (Njemačka)

REFERENCES Production line for assembling battery packages, BMW Leipzig (Germany); Production line for anticorrosion protection, BMW, Leipzig (Germany); Production line for protection caps on vehicle body, BMW Munich (Germany); Production line for dismantling vehicle carrier, BMW Dingolfing (Germany)

IZVOZNA TRŽIŠTA Njemačka
EXPORT MARKETS Germany





BYTE LAB GRUPA



Inovativno inženjersko poduzeće sa sjedištem u Zagrebu. Njihovo stručno područje obuhvaća niz usluga, uključujući razvoj elektroničkih proizvoda, inženjerske usluge (razvoj ugrađenog softvera i hardvera) te prototipiranje i proizvodnju – pružajući sveobuhvatno rješenje za potrebe dizajna i proizvodnje elektronike.

An innovative engineering company based in Zagreb. Their expertise includes a range of services, including electronic product development, engineering services (embedded software and hardware development), and prototyping and manufacturing – providing a comprehensive solution for design and electronics manufacturing needs.



Medarska ulica 69/1, Zagreb
www.byte-lab.com

Josip Puškar
puskarj@byte-lab.com

PROIZVODI

- Razvoj i proizvodnja elektroničkih uređaja
- Razvoj embedded softvera i hardvera
- Gasread AMR – Uređaj za daljinsko očitavanje plinomjera
- TS-AQU-LORA -Telemetrijski uređaj za nadzor trafostanica
- Kontroler AC uređaja

KEY PRODUCTS

- Development and manufacturing of electronic devices
- Embedded software and hardware development
- Gasread AMR – Remote gas meter reading device
- TS-AQU-LORA - Telemetry device for substation monitoring
- AC unit controller

KAPACITET PROIZVODNJE / ANNUAL PRODUCTION CAPACITY 100.000

STANDARDI I CERTIFIKATI STANDARDS AND CERTIFICATES ISO9001, ISO14001, ISO27001, IPC-A-610

REFERENCE REFERENCES HEP Plin, HEP ODS/Croatian Electricity Utility Company Distribution System Operator, MB Frigo Grupa/Group

IZVOZNA TRŽIŠTA EU, SAD, Švicarska, Norveška

EXPORT MARKETS EU, USA, Switzerland, Norway

Vodeće ime u industriji više od 30 godina. Isporučuju holističko potpuno opremljeno rješenje za pametne tvornice koje obuhvaća napredne strojeve, najsuvremeniji softver za upravljanje, vrhunsku robotiku i precizan strojni vid.

A leading name in the industry for over 30 years, standing at the forefront of Industry 4.0 evolution delivers a holistic full- featured smart factory solution encompassing advanced machinery, state-of- the-art management software, cutting-edge robotics, and precision machine vision.

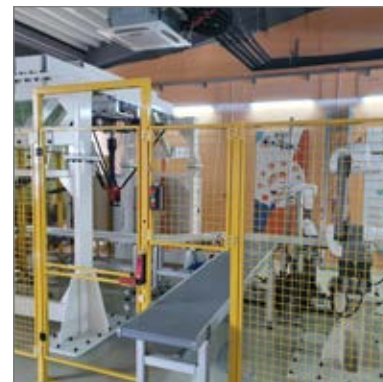

Ulica Franje Tuđmana 20,
Križevci
www.codel.hr
www.stock-master.co.uk

Matija Sever
matija.sever@codel.hr
+385 99 518 7600

PROIZVODI

- Stock Master serija pametnih polica (standardne, modularne, mobilne, paletne)
- AMR robots– HIK robots partneri (LMR, FMR, CTU)
- Nachi robots partner

KEY PRODUCTS

- Stock Master series of smart shelves (Standard, Modular, Mobile, Pallet)
- AMR robots – HIK robots partners (LMR, FMR, CTU)
- Nachi robots partner

REFERENCE REFERENCES BAT Adria, Alca, Franck, Enikon Aerospace, Ember kamini, SELK-TDK

STANDARDI I CERTIFIKATI STANDARDS AND CERTIFICATES ISO 9001, ISO 27000

IZVOZNA TRŽIŠTA EU, Ujedinjeno

Kraljevstvo

EXPORT MARKETS EU, United Kingdom

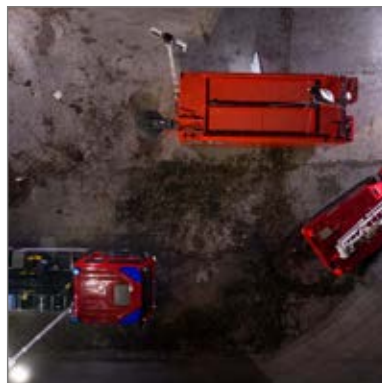

DOK-ING



Inženjerski lider u razvoju i proizvodnji robotskih i autonomnih sustava i opreme za posebne namjene specijalizirane za vojno inženjerstvo, NKBR ugroze, krizne situacije, protuterorizam i podzemno rudarstvo.

An engineering powerhouse of heavy-duty robotics & autonomous systems, specializing in Military Engineering, CBRNe, Emergency Response, Counter-Terrorism, and Underground Mining.



Slavonska avenija 22G, Zagreb
www.dok-ing.com

Mislav Manda
sales@dok-ing.hr

PROIZVODI KEY PRODUCTS

Robotski sustavi za / Robotic systems for
1. Vojna inženjerija i razminiranje / Military Engineering and Demining:

- MV-10 Bison (heavy duty)
- MV-4 Scorpion (multi mission)
- MV-2 Honey Badger (compact)

2. Protuterorizam / Counter-Terrorism:

- MV-3 Hystrix (Taktička prednost kroz mobilnost i zaštitu / Tactical advantage through mobility and protection)

3. Krizne situacije / Emergency response:

- MVF-5 Tusk (Upravljanje kriznim situacijama / Crisis management)
- MVC-8 Komodo (NKRB / CBRN)

4. Podzemno rudarstvo / Underground Mining:

- NRE Fleet (baterijski pogonjen / electric)
- XLPD Groundhog (dizel / diesel)

organizacije i agencije UN-a te komercijalni operateri

REFERENCES Armed Forces, Government Agencies, International NGOs and UN Agencies, Commercial Operators

KAPACITET PROIZVODNJE 80 robotskih sustava godišnje

ANNUAL PRODUCTION CAPACITY 80 robotic systems

STANDARDI I CERTIFIKATI STANDARDS AND CERTIFICATES ISO 9001:2015, ISO 14001:2015, ISO 50001:2018, ISO 45001:2018, ISO 3834-3:2021

IZVOZNA TRŽIŠTA SAD, Švedska, Irska, Italija, Grčka, Austrija, Saudijska Arabija, Šri Lanka, Južna Koreja, Azerbajdžan i dr.

EXPORT USA, Sweden, Ireland, Italy, Greece, Austria, Saudi Arabia, Sri Lanka, South Korea, Azerbaijan, etc.

REFERENCE Oružane snage, vladine agencije, međunarodne nevladine

GIDEON BROTHERS

G I D E O N

Domaće poduzeće koje se bavi razvojem autonomnih mobilnih robota za logistiku i proizvodne pogone, s ciljem povećavanja produktivnosti pomoću najsvremenijih rješenja baziranih na umjetnoj inteligenciji.

Robotics and AI company that develops autonomous mobile robots for logistics and manufacturing, enhancing productivity with cutting-edge AI-powered solutions.



Šamačka 7, Osijek
www.gideon.ai

Dario Ljubić
sales@gideon.ai

PROIZVODI TREY

- Rješenje za autonomni utovar i istovar kamiona

KEY PRODUCTS

- TREY – Autonomous trailer loading and unloading

REFERENCE Gideon je implementirao robote u logistici, prehrambenoj industriji, industriji pića, auto industriji i proizvodnji papira.

REFERENCES Gideon has implemented robots in logistics, food industry, beverage industry, automobile industry, and paper production

STANDARDI I CERTIFIKATI Direktiva o strojevima 2006/42/EZ, EMC Direktiva 2014/30/EU, Gideonova vozila dizajnirana su u skladu sa svim relevantnim industrijskim standardima

STANDARDS AND CERTIFICATES Machine Directive 2006/42/EC, EMC Directive 2014/30/EU, Gideon's vehicles are designed according to all relevant industry standards

IZVOZNA TRŽIŠTA Sjeverna Amerika i Europa
EXPORT MARKETS North America and Europe



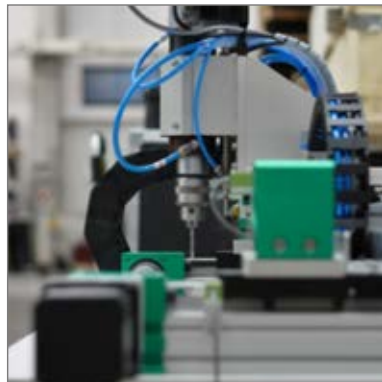
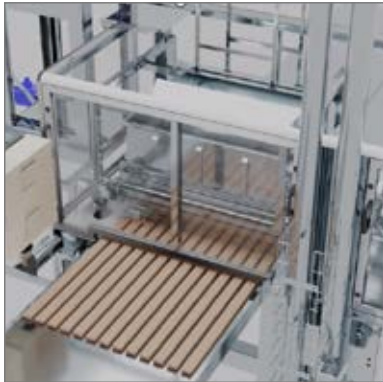

HENNLICH INDUSTRIJSKA TEHNIKA



Osnovna djelatnost poduzeća je prodaja, montaža i servis industrijskih proizvoda na bazi ekskluzivnih zastupanja renomiranih inozemnih proizvođača. Pored zastupanja pokrenuta je i vlastita proizvodnja robotskih (automatiziranih) sustava, izmjenjivača topline, zračnih hladnjaka, hidrauličnih brtvi, vodenih topova i sl. Zbog širokog prodajnog asortimana, u mogućnosti su ponuditi rješenja „ključ u ruke“.

The main activity of the company is the sale, assembly, and service of industrial products on the basis of exclusive representation of renowned foreign manufacturers. In addition to representation, they also started their own production of robotic (automated) systems, heat exchangers, air coolers, hydraulic seals, water guns, etc. Due to their wide range of products, they are able to offer customers turnkey solutions.



Stupničkoobreška 17,
Gornji Stupnik
www.hennlich.hr

Aleksandra Sunjog
aleksandra.sunjog@hennlich.hr

PROIZVODI

- Roboti (kolaborativni, industrijski, delta roboti),
- individualna rješenja automatizacije,
- energetske lance, fleksibilni kabeli, pumpe, spojnice za vodu, ventili, filteri, mlaznice

KEY PRODUCTS

- Robots (collaborative, industrial, delta robots),
- individual automation solutions,
- energy chains, flexible cables, pumps, water connectors, valves, filters, nozzles

REFERENCE REFERENCES Harburg

Freudenberger, Kostwein, Multinorm, HRID, Knaufinsulation, PIK-Vrbovec, Naše Klasje, EMPWR, INA-Industrija nafte, HEP, FSB, Pivovara Daruvar, Koprivničke vode, ViO Zagreb

STANDARDI I CERTIFIKATI STANDARDS AND CERTIFICATES ISO 9001:2015, ISO 14001:2015

IZVOZNA TRŽIŠTA EU, BiH, Srbija
EXPORT MARKETS EU, Bosnia and Herzegovina, Serbia

INETEC-INSTITUT ZA NUKLEARNU TEHNOLOGIJU



Svjetski lider u razvoju i proizvodnji robotskih sustava, instrumenata, sondi i software-a za nerazorna ispitivanja u nuklearnoj industriji. Poduzeće može ponuditi individualizirana rješenja po principu “ključ u ruke”.

Leading-edge developer and supplier of robots, instruments, probes and software for non-destructive testing of nuclear power plants. Company is able to produce customized turn-key solution.



Dolenica 28, Donji Stupnik
www.inetec.hr

Filip Gjetvaj
inetec@inetec.hr

PROIZVODI KEY PRODUCTS

- robotski sustavi za inspekcije na nuklearnim elektranama / robotic systems for nuclear power plant inspections
- ultrazvučni i eddy-current instrumenti i sonde / ultrasound and eddy-current instruments and probes
- razvoj specijaliziranih sustava za nerazorne inspekcije / development of specialized systems for non-destructive inspections

REFERENCE REFERENCES

Osnovna djelatnost / Core business: NE Krško, NE Paks, NE Barakah (UAE), NE Loviisa, NE Olkiluoto, NE Cernavoda, NE Kozloduy, ANPP
Inovativni projekti / Innovation projects: ITER i Dones projekti nuklearne fuzije / ITER and Dones fusion projects

STANDARDI I CERTIFIKATI STANDARDS AND CERTIFICATES ISO 9001, ISO 14001, ISO 45001, ISO/IEC 17025, ASME Code

IZVOZNA TRŽIŠTA Cijeli svijet
EXPORT MARKETS Worldwide



PROBOTICA

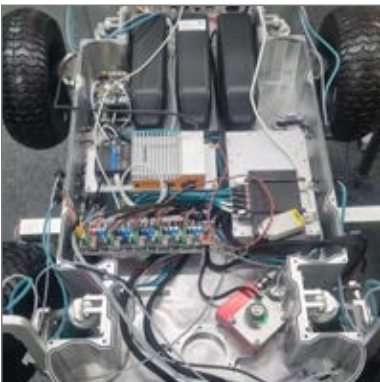
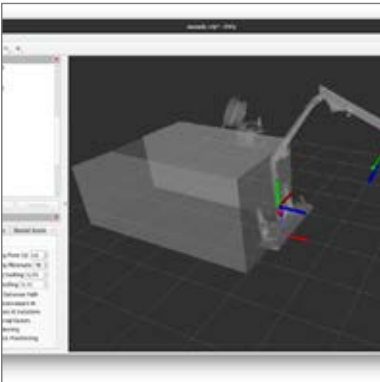

Poduzeće koje nudi širok spektar usluga u područjima robotike, mehatronike i procesne industrije. Njihovo stručno znanje leži u stvaranju inovativnih proizvoda i pružanju sveobuhvatnih usluga u području robotike i mehatronike. Njihov tim samostalno pokriva tri ključne discipline bitne za razvoj robotike: mehanički dizajn, elektroniku i razvoj softvera.

Offers a wide range of services in the fields of robotics, mechatronics, and the process industry. Their expertise is creating innovative products and offering comprehensive services in robotics and mechatronics. Their team independently covers the three essential disciplines crucial for robotics development: mechanical design, electronics, and software development.



Slavonska avenija 6A, Zagreb
www.probotica.hr

Miljenko Hrman
miljenko.hrman@probotica.hr

PROIZVODI

- Razvoj mobilnih robotskih sustava
- Razvoj softvera u okolini ROS/ROS2
- Mehanički razvoj robotskih sustava
- Razvoj i podrška certifikaciji proizvoda

REFERENCE Razvoj mobilnog robota za čišćenje plaža – HORIZON 2020, razvoj hidrauličke robotske ruke – za DOK-ING d.o.o.
REFERENCES development of a mobile robot for cleaning beaches HORIZON-2020, development of hydraulic robotic arm – for DOK-ING Ltd Croatia

KEY PRODUCTS

- Mobile robot development
- Software development in the ROS/ROS2 environment
- Mechanical design of components and robotic systems
- Development and product certification support

STANDARDI I CERTIFIKATI STANDARDS AND CERTIFICATES ISO 9001

PROEL AUTOMATIZACIJA



Mlado poduzeće bogatog iskustva u području automatizacije u industriji. Osnovna usluga bazira se na projektiranju i izgradnji jednostavnih ili zahtjevnih industrijskih sustava prilagođenih zahtjevu korisnika.

A young company with a rich experience in the field of industrial automation. Their core service is based on designing and building simple or complex industrial systems tailored to the user's requirements.



Radnička cesta 177, Zagreb
www.proel-automatizacija.hr
www.proel.hr

Dario Novak
+385 1 5588 988

PROIZVODI / KEY PRODUCTS

- SCADA
- PLC
- EPLAN projektiranje / design
- elektro ormari / electrical panels
- servo sustavi / systems
- roboti / robots
- Machine Vision
- CNC
- OEE/KPI
- sustavi vaganja / weighing systems

REFERENCE REFERENCES Pliva, JGL, Pfizer, Belupo, Genera, ACG Lukaps, Cemex, NEXE, KronoSPan, Rofix, TPV, ISKRA, Podravka, Zdenka, Coca-Cola, HiPP, ELDA, Colas, Vertiv, Siemens, ABB, NIPRO, HEPLAST PIPE

STANDARDI I CERTIFIKATI ISO 9001, GAMP, ABB integrator sustava, Siemens ovlaštenu partner za dodanu vrijednost, Yaskawa integrator sustava

STANDARDS AND CERTIFICATES ISO 9001, GAMP, ABB System Integrator, Siemens Added Value Reseller, Yaskawa Sistem Integrator

IZVOZNA TRŽIŠTA BiH, Slovenija, Mađarska, Italija, Francuska

EXPORT MARKETS Bosnia and Herzegovina, Slovenia, Hungary, Italy, France

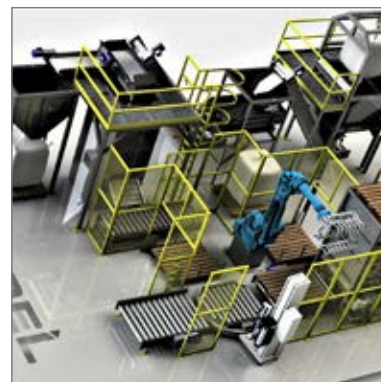

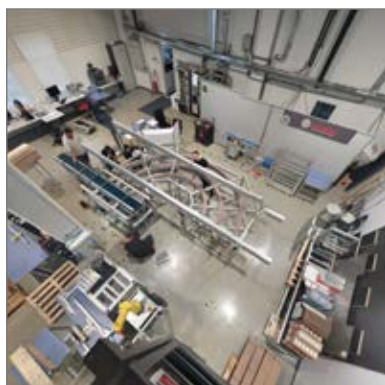

PURIĆ



Odjel automatizacije i robotike (Damko) poduzeća Purić integrator je elemenata automatizacije i proizvođač vlastitih rješenja. Prostor razvojnog centra pouzeca, omogućava sastavljanje kompletnih linija te puštanje u pogon i podešavanje prije isporuke i ugradnje na konačnu adresu kupca (tzv. "FAT").

Company's Automation and Robotics Department (Damko) is an integrator of automation elements and a manufacturer of proprietary solutions (machinery). The Company's development center is equipped to assemble full production lines, ensuring they are fully operational and fine-tuned before being delivered and installed at the client's site (so-called 'FAT').



Andrije Hebranga 54, Samobor
www.puric.hr
www.damko.hr

Dino Skansi
dino.skansi@puric.hr
+385 99 1616 815

PROIZVODI

- Automatizirane proizvodne linije, linije za pakiranje, paletiranje, integracija robotskih ruku, sustavi računalnog vida sustavi bazirani na umjetnoj inteligenciji, autonomne robotske platforme (AGV), digitalizacija proizvodnih procesa itd.

KEY PRODUCTS

- Automated production lines, packaging lines, palletizing lines, integration of robotic arms, Artificial intelligence-based computer vision systems, autonomous robotic platforms, digitization of manufacturing processes etc.

KAPACITET PROIZVODNJE 5–8 većih proizvodnih linija godišnje, 10 manjih projekata godišnje

ANNUAL PRODUCTION CAPACITY 5–8 larger production lines, 10 smaller projects per year

STANDARDI I CERTIFIKATI STANDARDS AND CERTIFICATES ISO 9001

REFERENCE REFERENCES Vivera, Franck

IZVOZNA TRŽIŠTA Slovenija, Austrija, Italija, Skandinavija

EXPORT MARKETS Slovenia, Austria, Italy, Scandinavia

ROMB TECHNOLOGIES



Poduzeće za razvoj softvera za autonomnu navigaciju u intralogistici. Njihovi moduli rješavaju ključne probleme poput izgradnje karte, lokalizacije, planiranja i praćenja putanje. Njihova rješenja se lako integriraju s postojećim procesima, povećavajući pouzdanost i učinkovitost logističkih operacija.

IT firm that develops software for autonomous navigation in intralogistics. Their modules tackle key issues like mapping, localization, planning, and path tracking. Their solutions integrate seamlessly with existing processes, boosting reliability and efficiency in logistics operations.



Martićeva 55, Zagreb
romb-technologies.hr

Damjan Miklič
damjan@romb-technologies.hr

PROIZVODI

- navigacijski softver za rukovanje materijalom
- izrada karte prostora
- lokalizacija
- precizno praćenje putanje
- softver za projektiranje AGV putanja, puštanje u pogon i praćenje operacija
- integracija hardvera i softvera za AGV/AMR
- specijalizirani razvoj i obuka za navigacijske sustave visoke točnosti
- obrazovanje iz mobilne robotike

KEY PRODUCTS

- Navigation software for material handling
- Map building

- Localization
- Accurate path following
- AGV Roadmap design, commissioning and monitoring software
- Hardware and software integration for AGVs/AMRs
- Specialized development and training for high-accuracy navigation systems
- Mobile robotics education

REFERENCE REFERENCES System

Logistics, RV Automation, OMCO Croatia

IZVOZNA TRŽIŠTA Italija, Litva, Kina

EXPORT MARKETS Italy, Lithuania, China

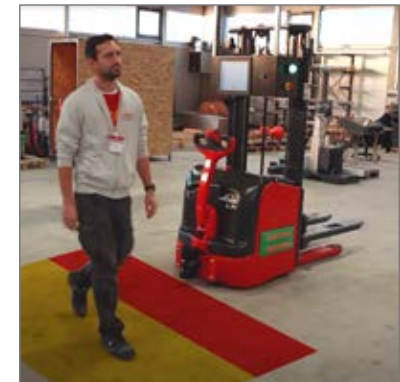

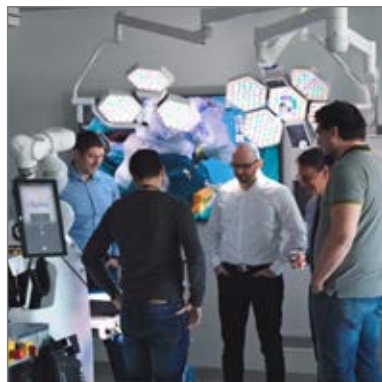

RONNA MEDICAL



Poduzeće razvija vrhunske medicinske proizvode, integrirajući najnovije tehnologije za poboljšanje zdravstvene skrbi. Njihov glavni proizvod, RONNA G6, je neurokirurški robotski sustav nove generacije s haptičkom povratnom informacijom za veću sigurnost i preciznost tijekom operacija. Funkcije poput automatske lokalizacije pacijenta i autonomne vožnje čine ga vrhunskim izborom za kirurge.

The company develops cutting-edge medical products, integrating latest technologies to improve healthcare. Their key product, the RONNA G6, is a next-generation neurosurgical robotic system with haptic feedback for increased safety and precision during operations. Features like automatic localization and autonomous driving make it a top choice for surgeons.



Slavonska avenija 6, Zagreb
www.ronna-medical.com

Andrei Krapotkin, managing director
+385 1 4400 230
info@ronna-medical.com

PROIZVODI

- Modularni robotski sustav RONNA G6
- RONNA stanica za planiranje
- autonomna mobilna platforma
- stereovizijska kamera „RONNA vision“
- RONNA vodilica alata

KEY PRODUCTS

- Modular robotic system RONNA G6
- RONNA planning station
- autonomous mobile platform
- stereotactic camera “RONNA vision”
- RONNA tool guide

KAPACITET PROIZVODNJE 5–6 robotskih sistema RONNA G6

ANNUAL PRODUCTION CAPACITY 5–6 robotic systems RONNA G6

STEMI



Izrađuje Netflix platformu za STEM obrazovanje namijenjenu učenicima osnovnih i srednjih škola koja će nuditi STEM programe temeljene na projektima u području suvremenih tehnologija poput umjetne inteligencije, interneta stvari, robotike, kibernetičke sigurnosti, blockchaina, AR-a itd. Nudi jedinstvene STEM programe temeljene na industriji koji su rješenja spremna za upotrebu u učionici, prilagođeni tempu učenika, uz temeljitu obuku nastavnika i podršku u provedbi uživo.

An ed-tech company that is building a STEM education Netflix Platform for middle and high school students with project-based STEM programs in modern technologies such as AI, IoT, robotics, cybersecurity, blockchain, AR, etc. They offer unique, industry-based STEM programs that are plug-and-play solutions for the classroom, student-paced and come with thorough teacher training as well as in-person support in implementation.



R. Matejčić 10, Rijeka
stemi.education

Slobodan Velikić
slobodan@stemi.education

PROIZVODI KEY PRODUCTS

- STEMI Hexapod
- STEMI Lab
- STEMI AI Chatbot Program

KAPACITET GODIŠNJE PROIZVODNJE ANNUAL PRODUCTION CAPACITY

100 000

REFERENCE REFERENCES Carnet, Norwalk
PS, CT, Shelby County, TN, Prince George
County PS, MD, Koding Next, Mada Center

IZVOZNA TRŽIŠTA SAD, Katar, Indonezija, UK
EXPORT MARKETS USA, Qatar, Indonesia,
UK



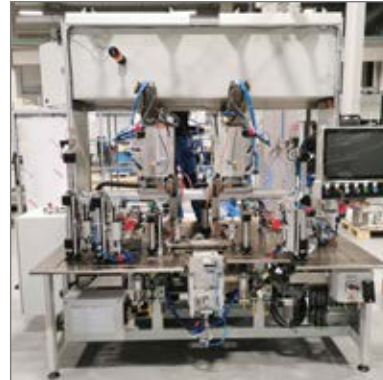

STROJOTEHNIKA



Poduzeće specijalizirano za robotiku, automatizaciju i proizvodnju specijalnih strojeva. Njihov tim stručnjaka razvija i implementira prilagođene robotske sustave, automatizirane linije i specijalne strojeve kako bi zadovoljili specifične potrebe klijenata. Mogu ponuditi konstrukcijsku razradu, elektroprojektiranje, PLC programiranje, programiranje robota, proizvodnju dijelova u vlastitim kapacitetima, elektro i mehaničku montažu, te naposljetku puštanje u pogon kod klijenta.

Company that specializes in robotics, automation, and the production of special machines. Their team of experts develops and implements customized robotic systems, automated lines, and specialty machines to meet the specific needs of their clients. They can offer structural development, electrical design, PLC programming, robot programming, production of parts in our own capacity, electrical and mechanical assembly, and finally commissioning at the client's location.



Zagorska 10, Soblinec,
Grad Zagreb
www.strojotehnika.hr

Ivan Bartolin
+385 91 281 6360
ivan.bartolin@strojotehnika.hr

PROIZVODI

- Robotske stanice
- Specijalni strojevi
- Automatizirane linije

KEY PRODUCTS

- Robotic stations
- Special machines
- Automated lines

REFERENCE REFERENCES Schaeffler special machinery GmbH, FELSS Systems GmbH, IPTE GmbH, Tekvor care GmbH

IZVOZNA TRŽIŠTA EU, BIH, Srbija
EXPORT MARKETS EU, Bosnia and Herzegovina, Serbia

V&R AUTOMATED SYSTEMS



Nude rješenja po principu „ključ u ruke“ za automatizaciju rukovanja materijalom. Nadogradnjom provjerenih viličarskih platformi s najsuvremenijom senzorskom i računalnom opremom i softverom, mogu ponuditi automatizirano vođena vozila (AGV) s vodećim mogućnostima na tržištu. Njihova se rješenja integriraju u postojeće tijekove rada kako bi se poboljšala učinkovitost i pouzdanost logističkih operacija njihovih klijenata.

They provide turnkey solutions for material handling automation. By upgrading proven brand-name forklift platforms with state of the art sensing and computing equipment, and software, they can offer automated guided vehicles (AGVs) with market-leading capabilities. Their solutions integrate into existing workflows to improve the efficiency and reliability of their client's logistics.

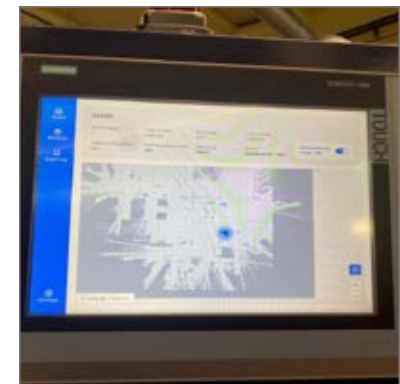

Ivana Keleka 18a, Sesvete
www.vandr-as.hr

Damjan Miklić
info@vandr-as.hr

PROIZVODI

- Automatizirano vođena vozila (AGV)
- Rješenja ključ u ruke za automatizaciju procesa rukovanja materijalima

KEY PRODUCTS

- Automated guided vehicles (AGVs)
- Turnkey solutions for material handling process automation

KAPACITET PROIZVODNJE 5 AGV strojeva
ANNUAL PRODUCTION CAPACITY 5 AGVs

REFERENCE OMCO Hrvatska –

Automatizacija transporta sirovina u proizvodnji staklenih kalupa

REFERENCES OMCO Croatia – Automation of raw materials transport in glass mould production

IZVOZNA TRŽIŠTA Austrija, Mađarska, Slovenija, Italija, BiH, Srbija

EXPORT MARKETS Austria, Hungary, Slovenia, Italy, Bosnia and Herzegovina, Serbia



KONTAKTI

Autor ove publikacije pod nazivom Katalog hrvatskih proizvođača – ROBOTIKA je Ministarstvo gospodarstva i održivog razvoja, a partner Regionalni centar izvrsnosti za robotske tehnologije (CRTA) pri Fakultetu strojarstva i brodogradnje Sveučilišta u Zagrebu.

Uprava za internacionalizaciju pri Ministarstvu zadužena je za pružanje podrške domaćim poduzećima u procesu izlaska na strana tržišta, ali i stranim investitorima koji ulažu u Republiku Hrvatsku.

CONTACTS

The author of the publication Catalogue of Croatian Manufacturers – ROBOTICS is the Ministry of Economy and Sustainable Development, with the partner Regional Centre of Excellence for Robotic Technology (CRTA) at the Faculty of Mechanical Engineering and Naval Architecture, University of Zagreb.

The Ministry's Directorate for Internationalization is responsible for providing support to domestic companies in the process of entering foreign markets, as well as to foreign investors investing in the Republic of Croatia.

MINISTARSTVO GOSPODARSTVA I ODRŽIVOG RAZVOJA
MINISTRY OF ECONOMY AND SUSTAINABLE DEVELOPMENT

Ulica grada Vukovara 78, Zagreb
+385 1 6106 444

internacionalizacija@mingor.hr
export@mingor.hr
mingor.gov.hr
investcroatia.gov.hr

SVEUČILIŠTE U ZAGREBU, FAKULTET STROJARSTVA I BRODOGRADNJE
REGIONALNI CENTAR IZVRSNOSTI ZA ROBOTSKE TEHNOLOGIJE – CRTA
UNIVERSITY OF ZAGREB, FACULTY OF MECHANICAL ENGINEERING AND NAVAL
ARCHITECTURE
REGIONAL CENTRE OF EXCELLENCE FOR ROBOTIC TECHNOLOGY – CRTA

Ul. Ivana Lučića 5, Zagreb
+385 99 675 0305

crt@fsb.hr
crt-robotics.com

Izjava o odricanju od odgovornosti: Ministarstvo gospodarstva i održivog razvoja nije odgovorno za potpunost, točnost i ažurnost informacija iz nadležnosti drugih institucija, tijela ili pravnih subjekata, stoga sugeriramo korisnicima da navedene informaciju dodatno provjere s nadležnim poduzećem. Istovremeno upućujemo zamolbu da nam se prijavi svaka eventualna pogreška, odnosno netočno navedena informacija koja se uoči i/ili utvrdi u ovoj publikaciji.

Disclaimer: The Ministry of Economy and Sustainable Development of the Republic of Croatia has used its best endeavours to ensure that the information is correct and current at the time of publication and shall take no responsibility for any error, omission or defect of third party information. The Ministry shall provide no warranty or approval for third-party information and we suggest to the publication users to additionally check information listed in the publication with the competent company. Please inform us in case of any error or incorrect information that has been observed in the publication.



REPUBLIKA HRVATSKA
Ministarstvo gospodarstva
i održivog razvoja



REPUBLIC of CROATIA
Ministry of Economy and
Sustainable Development